



ROBBER'S

INDUSTRIAL
2016-2018



ROBERERS[®]





Seit 1964 werden in unserem Familienunternehmen in Südlohn Leuchten auf höchstem Niveau und in hoher Qualität hergestellt.

Die Marke ROBERS steht für Tradition, Nachhaltigkeit und zeitlose Gestaltung. Entwicklung und Fertigung befinden sich unter einem Dach in unserem Werk in Südlohn. Dadurch erreichen wir eine sehr große Flexibilität. Die Leuchten werden von erfahrenen Schmieden in sorgfältiger Handarbeit hergestellt somit wird jedes Stück zu einem Unikat.

Die verschiedenen Standardoberflächen haben wir auf Seite 82 abgebildet. Es werden nur hochwertige Materialien wie seewasserbeständiges Aluminium, Grauguß, Stahl – feuerverzinkt, Edelstahl und Kupfer verwendet.

Unsere Leuchten werden lichttechnisch ständig weiterentwickelt und können selbstverständlich mit LEDs und anderen innovativen Leuchtmitteln bestückt werden. Dadurch sind sie für die Zukunft gerüstet.

Die Leuchten sind anschlussfertig verdrahtet und nur mit hochwertigsten elektrischen Komponenten bestückt.

Aufgrund unserer Fertigungsmöglichkeiten sind wir in der Lage auf persönliche Kundenwünsche einzugehen. Dabei können wir nach Ihren Vorstellungen arbeiten oder Entwürfe für Sie ausarbeiten. Zeitlose Gestaltung, moderne LED-Technik, Industriestahl und leidenschaftliche Handwerkskunst bilden die Basis für unsere INDUSTRIAL Produktserie.



Since 1964 we have been producing high quality lighting fixtures in our family owned company in Südlohn / Germany.

The brand ROBERS symbolizes tradition, sustainability and timeless design. Development and production are under one roof at our plant in Südlohn. Thus, we achieve a high degree of flexibility.

Our lighting fixtures are carefully crafted by experienced blacksmiths. In this way each item becomes a unique touch.

For different finishes see page 82. Only high-quality materials are used such as seawaterresistant aluminium, cast iron, hot-galvanized steel, stainless steel and copper.

Our lighting fixtures are constantly evolving regarding lighting technology and can of course be equipped with LEDs and other innovative light sources. Thus they are well prepared for the future.

The lighting fixtures are ready for installation at site and are equipped with high class electrical components.

Due to our manufacturing capabilities we can respond to special customer requests. Hereby we can realize your own ideas or we can give you our proposals.

Timeless design, modern LED technology, hard steel and passionate craftsmanship are the base for our INDUSTRIAL product line.

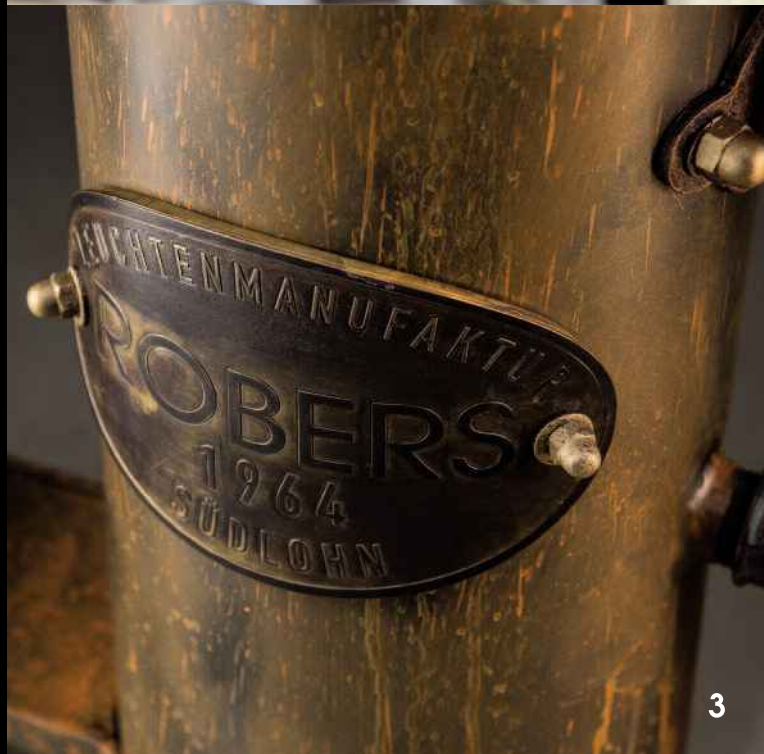



 Начиная с 1964 года на нашем семейном предприятии в городе Зюдлон в Германии мы производим светильники высочайшего качества.

Марка Robers – это традиции, основательность и классический дизайн.

Новые идеи светильников рождаются в нашем доме и здесь же воплощаются в жизнь высококлассными мастерами ручнойковки. Это позволяет очень гибко реагировать на пожелания клиентов. Каждая работа мастеров уникальна.

В производстве используются только высококачественные материалы, такие как устойчивый к воздействию морской воды алюминий, чугун, оцинкованная сталь и медь.

Образцы покрытий, используемых при производстве изделий, представлены на странице 82.



Мы идем в ногу с техническими инновациями и уже сегодня оснащаем светильники светодиодными (LED) и другими современными энергосберегающими источниками света.

Светильники поставляются укомплектованными только высококачественными электрическими компонентами и готовы к установке.

Наши производственные возможности позволяют осуществить самые изысканные пожелания клиента. Мы реализуем ваши представления по разработанному нами эскизу.





Depuis 1964 notre entreprise familiale installée à Südlohn en Allemagne produit des luminaires de prestige d'une qualité remarquable.

La marque Robers est reconnue pour l'authenticité et la valeur ajoutée de leurs créations intemporelles. Le fait de développer et de fabriquer les produits dans l'usine de Südlohn apporte une très grande souplesse d'adaptation. Les lampes sont réalisées dans le respect des traditions artisanales afin que chaque pièce reste unique.

Le panel des différentes finitions est représenté à la page 82.

Un design intemporel, une technologie LED moderne, de l'acier et des artisans passionnés constituent l'essence de notre ligne INDUSTRIAL.

Nous n'utilisons que des matériaux de grande qualité comme de l'aluminium insensible à l'eau de mer, de la fonte, de l'acier galvanisé à chaud, de l'innox, du bronze.

Nos lampes évoluent constamment et sont adaptées à recevoir des Leds et les nouvelles techniques d'éclairage.

Les lampes sont dotées de câblages et de composants électriques de qualité. Elles sont livrées prêt à brancher.

Grâce à notre adaptabilité, nous sommes en mesure de satisfaire les souhaits de nos clients. Nous pouvons travailler selon vos critères ou développer pour vous des projets spécifiques.



HL 2610



HL 2610
HÄNGELEUCHE / SUSPENSION LAMP

FASSUNG / SOCKET:	3 X E 27 / 3 X E 26
LÄNGE / LENGTH:	970 MM / 38"
BREITE / WIDTH:	115 MM / 4,5"
HÖHE / HEIGHT:	446 MM / 17,5"
OBERFLÄCHE / FINISH:	EISEN NATUR / IRON-NATURE
GEWICHT / WEIGHT:	14 KG

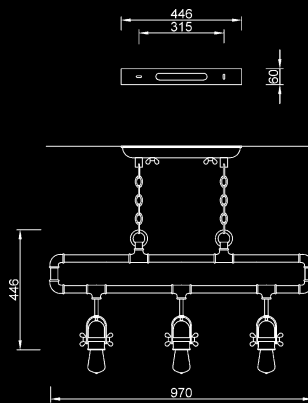

LED MULTIFILAMENT DIMMABLE





SL 109
STEHLEUCHE / FLOOR LAMP

FASSUNG / SOCKET:
BREITE / WIDTH:
TIEFE / DEPTH:
HÖHE / HEIGHT:
OBERFLÄCHE / FINISH:
GEWICHT / WEIGHT:

1 X E 27 / 1 X E 26
360 MM / 14"
270 MM / 10,5"
1420 MM / 56"
EISEN NATUR / IRON-NATURE
15 KG

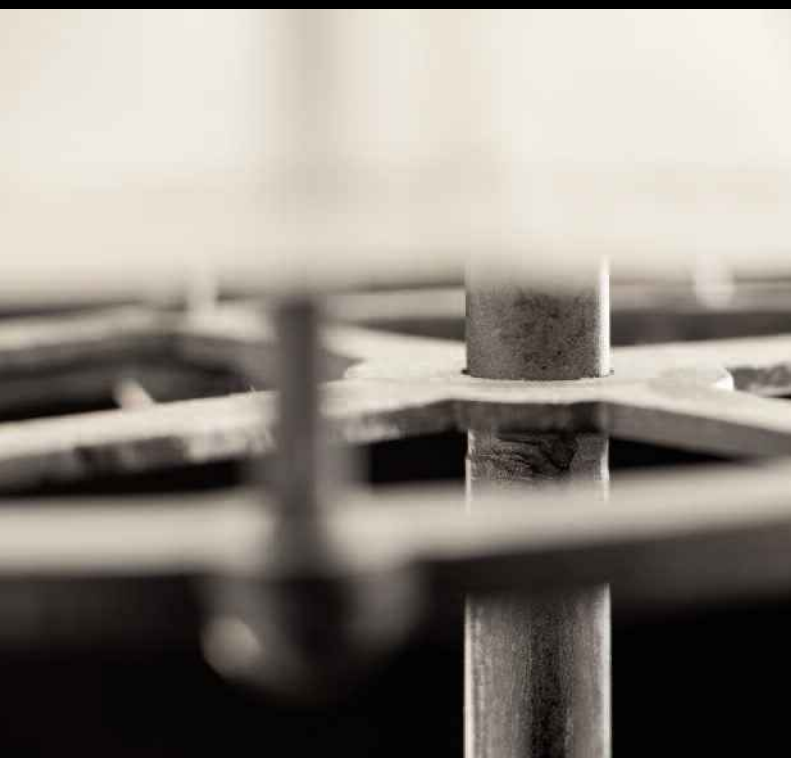

SL 109



HL 2623
HÄNGELEUCHE / SUSPENSION LAMP

FASSUNG / SOCKET:	4 X E 27 / 4 X E 26
BREITE / WIDTH:	580 MM / 23"
HÖHE / HEIGHT:	530 MM / 21"
OBERFLÄCHE / FINISH:	EISEN NATUR / IRON-NATURE
GEWICHT / WEIGHT:	10 KG

WL 3629
WANDELEUCHE / WALL LAMP

FASSUNG / SOCKET:	1 X E 27 / 1 X E 26
AUSLADUNG / DISTANCE TO WALL:	148 MM / 6"
BREITE / WIDTH:	130 MM / 5"
HÖHE / HEIGHT:	264 MM / 10,5"
OBERFLÄCHE / FINISH:	EISEN NATUR / IRON-NATURE
GEWICHT / WEIGHT:	1,8 KG

DIE GESAMTHÖHE DER LEUCHE, INKLUSIVE AUFHÄNGUNG, WIRD IHREM WUNSCH ENTSPRECHEND GEFERTIGT.

THE OVER ALL HEIGHT OF THIS FIXTURE WILL BE MADE ACCORDING TO YOUR REQUIREMENTS.

LA HAUTEUR TOTALE DU LUMINAIRE, SYSTEME D'ATTACHE COMPRIS, SERA CONFECTIONNÉ SELON VOS SOUHAITS.

WL 3629



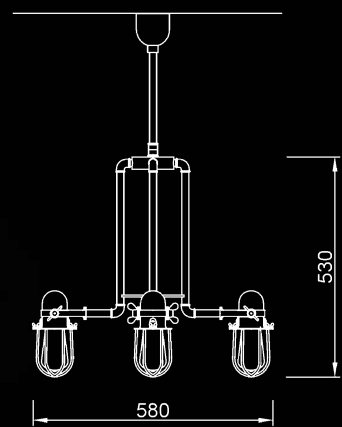

HL 2623





HL 2620



HL 2620 HÄNGELEUCHE / SUSPENSION LAMP

FASSUNG / SOCKET:	1 X E 27 / 1 X E 26
BREITE / WIDTH:	122 MM / 5"
HÖHE / HEIGHT:	207 MM / 8"
OBERFLÄCHE / FINISH:	EISEN NATUR / IRON-NATURE
GEWICHT / WEIGHT:	3,4 KG

DIE GESAMTHÖHE DER LEUCHE, INKLUSIVE AUFHÄNGUNG, WIRD IHREM WUNSCH ENTSPRECHEND GEFERTIGT.

THE OVER ALL HEIGHT OF THIS FIXTURE WILL BE MADE ACCORDING TO YOUR REQUIREMENTS.

LA HAUTEUR TOTALE DU LUMINAIRE, SYSTEME D'ATTACHE COMPRIS, SERA CONFECTIONNÉ SELON VOS SOUHAITS.

SL 108 STEHLEUCHE / FLOOR LAMP

FASSUNG / SOCKET:	1 X E 27 / 1 X E 26
LÄNGE / LENGTH:	1110 MM / 44"
BREITE / WIDTH:	352 MM / 14"
HÖHE / HEIGHT:	1380 MM / 54"
OBERFLÄCHE / FINISH:	EISEN NATUR / IRON-NATURE
GEWICHT / WEIGHT:	12 KG



TL 4101 TISCHLEUCHE / TABLE LAMP

FASSUNG / SOCKET:	1 X E 27 / 1 X E 26
BREITE / WIDTH:	140 MM / 5,5"
TIEFE / DEPTH:	220 MM / 8,5"
HÖHE / HEIGHT:	446 MM / 17,5"
OBERFLÄCHE / FINISH:	EISEN NATUR / IRON-NATURE
GEWICHT / WEIGHT:	4 KG



TL 4101

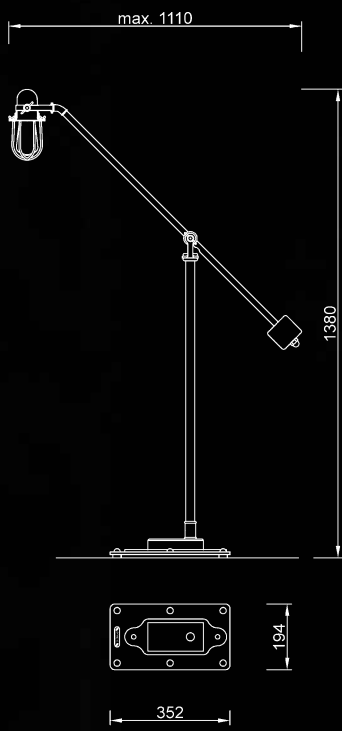

SL 108

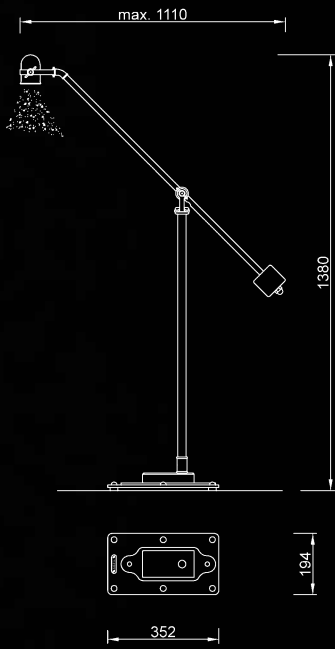

SL 110



HL 2621
HÄNGELEUCHE / SUSPENSION LAMP

FASSUNG / SOCKET: 1 X GU 10
BREITE / WIDTH: 122 MM / 5"
HÖHE / HEIGHT: 92 MM / 3,5"
OBERFLÄCHE / FINISH: EISEN NATUR / IRON-NATURE
GEWICHT / WEIGHT: 3,2 KG

DIE GESAMTHÖHE DER LEUCHE, INKLUSIVE AUFHÄNGUNG, WIRD IHREM WUNSCH ENTSPRECHEND GEFERTIGT.

THE OVER ALL HEIGHT OF THIS FIXTURE WILL BE MADE ACCORDING TO YOUR REQUIREMENTS.

LA HAUTEUR TOTALE DU LUMINAIRE, SYSTEME D'ATTACHE COMPRIS, SERA CONFECTIONNÉ SELON VOS SOUHAITS.

SL 110
STEHLEUCHE / FLOOR LAMP

FASSUNG / SOCKET: 1 X GU 10
LÄNGE / LENGTH: 1110 MM / 44"
BREITE / WIDTH: 352 MM / 14"
HÖHE / HEIGHT: 1380 MM / 54"
OBERFLÄCHE / FINISH: EISEN NATUR / IRON-NATURE
GEWICHT / WEIGHT: 12 KG



HL 2621





SL 106



HL 2609

3-FL. HÄNGELEUCHE / 3-LIGHTER SUSPENSION LAMP

FASSUNG / SOCKET:	3 X E 27 / 3 X E 26
LÄNGE / LENGTH:	1400 MM / 55"
BREITE / WIDTH:	200 MM / 8"
HÖHE / HEIGHT:	495 MM / 19,5"
SCHIRME / SHADES:	KAFFEESÄCKE, MOTIVE VARIIEREN / COFFEE BAGS, THEMES MAY VARY
OBERFLÄCHE / FINISH:	EISEN NATUR / IRON-NATURE
GEWICHT / WEIGHT:	8 KG

DIE GESAMTHÖHE DER LEUCHE, INKLUSIVE AUFHÄNGUNG, WIRD IHREM WUNSCH ENTSPRECHEND GEFERTIGT.

THE OVER ALL HEIGHT OF THIS FIXTURE WILL BE MADE ACCORDING TO YOUR REQUIREMENTS.

LA HAUTEUR TOTALE DU LUMINAIRE, SYSTEME D'ATTACHE COMPRIS, SERA CONFECTIONNÉ SELON VOS SOUHAITS.

SL 106 STEHLEUCHE / FLOOR LAMP

FASSUNG / SOCKET:	1 X E 27 / 1 X E 26
LÄNGE / LENGTH:	360 MM / 14"
BREITE / WIDTH:	220 MM / 5"
HÖHE / HEIGHT:	1750 MM / 69"
SCHIRM/SHADE:	KAFFEESACK, MOTIVE VARIIEREN / COFFEE BAG, THEMES MAY VARY
OBERFLÄCHE / FINISH:	EISEN NATUR / IRON-NATURE
GEWICHT / WEIGHT:	15 KG



HL 2609





SL 107



HL 2624

HL 2624

2-FL. HÄNGELEUCHTE / 2-LIGHTER SUSPENSION LAMP

FASSUNG / SOCKET:	2 X E 27 / 2 X E 26
LÄNGE / LENGTH:	1200 MM / 47"
BREITE / WIDTH:	400 MM / 16"
HÖHE / HEIGHT:	417 MM / 16,5"
Ø BALDACHIN / Ø CANOPY:	170 MM / 6,5"
OBERFLÄCHE / FINISH:	OLD BRONZE
GEWICHT / WEIGHT:	11 KG

DIE GESAMTHÖHE DER LEUCHTE, INKLUSIVE AUFHÄNGUNG, WIRD IHREM WUNSCH ENTSPRECHEND GEFERTIGT.

THE OVER ALL HEIGHT OF THIS FIXTURE WILL BE MADE ACCORDING TO YOUR REQUIREMENTS.

LA HAUTEUR TOTALE DU LUMINAIRE, SYSTEME D'ATTACHE COMPRIS, SERA CONFECTIONNÉ SELON VOS SOUHAITS.

SL 107

STEHLEUCHTE / FLOOR LAMP

FASSUNG / SOCKET:	1 X E 27 / 1 X E 26
LÄNGE / LENGTH:	360 MM / 14"
BREITE / WIDTH:	300 MM / 12"
HÖHE / HEIGHT:	1750 MM / 69"
OBERFLÄCHE / FINISH:	EISEN NATUR / IRON-NATURE
GEWICHT / WEIGHT:	16 KG

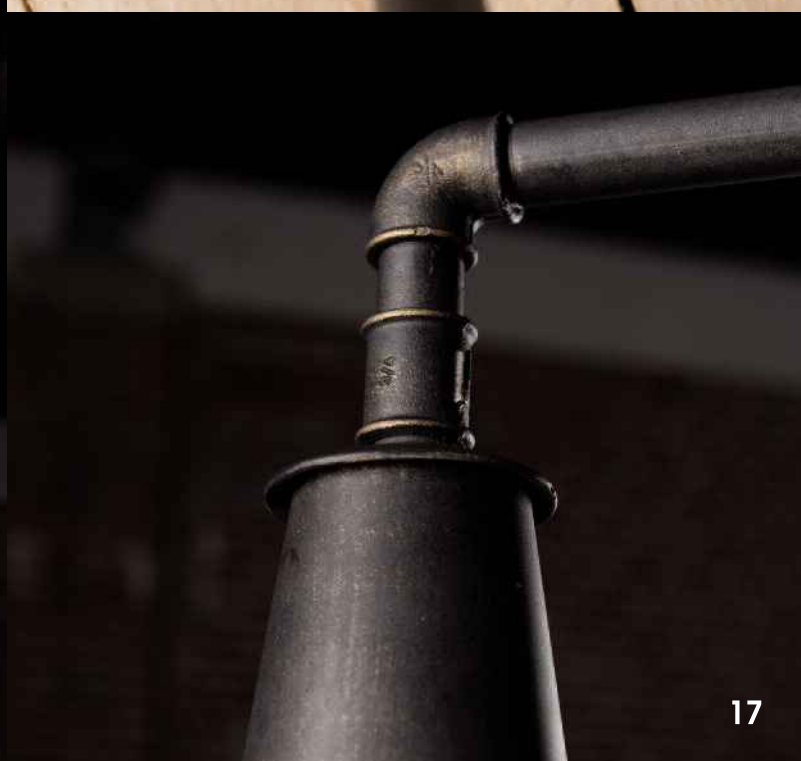



HL 2569-400 HÄNGELEUCHTE/SUSPENSION LAMP

FASSUNG / SOCKET: 1 X E 27 / 1 X E 26
 DURCHMESSER / DIAMETER: 400 MM / 15,7"
 HÖHE / HEIGHT - GEWICHT / WEIGHT: 276 MM / 11" - 4 KG
 LACKIERUNG / FINISH: EISEN NATUR / IRON-NATURE

HL 2569-500 HÄNGELEUCHTE / SUSPENSION LAMP

DURCHMESSER / DIAMETER - GEWICHT / WEIGHT: 500 MM / 20" - 6 KG

DIE GESAMTHÖHE DER LEUCHTE, INKLUSIVE AUFHÄNGUNG, WIRD IHREM WUNSCH ENTSPRECHEND GEFERTIGT.
 THE OVER ALL HEIGHT OF THIS FIXTURE WILL BE MADE ACCORDING TO YOUR REQUIREMENTS.

LA HAUTEUR TOTALE DU LUMINAIRE, SYSTEME D'ATTACHE COMPRIS, SERA CONFECTIONNÉ SELON VOS SOUHAITS.

TL 4100 TISCHLEUCHTE / TABLE LAMP

FASSUNG / SOCKET: 1 X E 27 / 1 X E 26
 HÖHE / HEIGHT: 250 MM / 10"
 DURCHMESSER / DIAMETER: 160 MM / 6"
 GLAS / GLASS: NR347 OPALWEISS / OPAL WHITE
 LACKIERUNG / FINISH: EISEN NATUR / IRON-NATURE
 GEWICHT / WEIGHT: 2 KG

KL 229 KERZENLEUCHTER / CANDLE STICK

HÖHE / HEIGHT: 90 MM / 3,5"
 DURCHMESSER / DIAMETER: 160 MM / 6"
 LACKIERUNG / FINISH: EISEN NATUR / IRON-NATURE
 GEWICHT / WEIGHT: 1 KG



TL 4100



KL 229



HL 2569-400



HL 2560
21-FL. HÄNGELEUCHE / 21-LIGHTER SUSPENSION LAMP

FASSUNG / SOCKET:	21 X E 27 / 21 X E 26
MIT / WITH DOWNLIGHTS:	3 X GU 10
DURCHMESSER / DIAMETER:	1000 MM / 39,4"
HÖHE / HEIGHT:	1020 MM / 40,2"
GLAS / GLASS:	9 X NR345-OM / 9 X NR346-OM / 3 X NR347-OM
LACKIERUNG / FINISH:	EISEN NATUR / IRON-NATURE
BALDACHIN / CANOPY:	B-NR 39
GEWICHT / WEIGHT:	65 KG

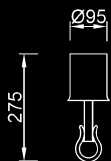

DIESE LEUCHTENSERIE KANN IN ALLEN SONDERGRÖSSEN GEFERTIGT WERDEN.
THIS PRODUCT LINE CAN BE MODIFIED IN ALL SIZES.
CETTE SÉRIE DE LUMINAIRE PEUT ÊTRE RÉALISÉE SUR MESURE.



HL 2560



WL 3576

WL 3576
WANDLEUCHTE / WALL LAMP

FASSUNG / SOCKET:	9 X E 27 / 9 X E 26
BREITE / WIDTH:	1250 MM / 50"
HÖHE / HEIGHT:	500 MM / 19,5"
AUSLADUNG / DISTANCE TO WALL:	185 MM / 7,5"
GLAS / GLASS:	2 X NR345-OM / 3 X NR346-OM / 4 X NR347-OM
LACKIERUNG / FINISH:	EISEN NATUR / IRON-NATURE
GEWICHT / WEIGHT:	20 KG

HL 2509
8-FL. HÄNGELEUCHTE / 8-LIGHTER SUSPENSION LAMP

FASSUNG / SOCKET:	8 X E 27 / 8 X E 26
MIT / WITH 2 DOWNLIGHTS:	2 x GU 10
BREITE / WIDTH:	130 MM / 5"
HÖHE / HEIGHT:	270 MM / 10"
LÄNGE / LENGTH:	1180 MM / 47"
GLAS / GLASS:	3 X NR345-OM / 3 X NR346-OM / 2 X NR347-OM
LACKIERUNG / FINISH:	EISEN NATUR / IRON-NATURE
GEWICHT / WEIGHT:	18 KG



HL 2509





WL 3484

WL 3484 WANDLEUCHTE / WALL LAMP

FASSUNG / SOCKET:	1 X E 27 / 1 X E 26
BREITE / WIDTH:	165 MM / 6"
HÖHE / HEIGHT:	335 MM / 13"
AUSLADUNG / DISTANCE TO WALL:	185 MM / 7"
GLAS / GLASS:	1 X NR347-OM
LACKIERUNG / FINISH:	OLD BLACK
GEWICHT / WEIGHT:	3,8 KG

WL 3484-ST WANDLEUCHTE / WALL LAMP

FASSUNG / SOCKET:	1 X E 27 + GU 10 / 1 X E 26 + GU 10
BREITE / WIDTH:	165 MM / 6"
HÖHE / HEIGHT:	335 MM / 13"
AUSLADUNG / DISTANCE TO WALL:	185 MM / 7"
GLAS / GLASS:	1X NR347-OM
LACKIERUNG / FINISH:	PATINA
GEWICHT / WEIGHT:	4,8 KG

WL 3603 WANDLEUCHTE / WALL LAMP

FASSUNG / SOCKET:	3 X E 27 + 1 X GU 10 / 3 X E 26 + 1 X GU 10
BREITE / WIDTH:	387 MM / 15"
HÖHE / HEIGHT:	335 MM / 13"
AUSLADUNG / DISTANCE TO WALL:	185 MM / 7"
GLAS / GLASS:	1 X NR345-OM / 1 X NR346-OM / 1 X NR347-OM
LACKIERUNG / FINISH:	PATINA
GEWICHT / WEIGHT:	11 KG



WL 3484-ST



WL 3603



WL 3625 WANDLEUCHE / WALL LAMP

FASSUNG / SOCKET: 1 X E 27 / 1 X E 26
AUSLADUNG / DISTANCE TO WALL: 220 MM / 8,5"
BREITE / WIDTH: 100 MM / 4"
HÖHE / HEIGHT: 1300 MM / 51,2"
GLAS / GLASS: NR346-OM
LACKIERUNG / FINISH: EISEN NATUR / IRON-NATURE
GEWICHT / WEIGHT: 6,4 KG

SL 105 STEHLEUCHE / FLOOR LAMP

FASSUNG / SOCKET: 2 X E 27 / 2 X E 26
BREITE / WIDTH: 410 MM / 16"
HÖHE / HEIGHT: 1840 MM / 72,5"
GLAS / GLASS: NR346-OM
LACKIERUNG / FINISH: EISEN NATUR / IRON-NATURE
GEWICHT / WEIGHT: 20 KG

TL 4102 TISCHLEUCHE / TABLE LAMP

FASSUNG / SOCKET: 1 X E 27 / 1 X E 26
BREITE / WIDTH: 300 MM / 12"
HÖHE / HEIGHT: 676 MM / 26,5"
GLAS / GLASS: NR346-OM
LACKIERUNG / FINISH: EISEN NATUR / IRON-NATURE
GEWICHT / WEIGHT: 9 KG



SL 105

TL 4102



WL 3625



WL 3616



WL 3616
WANDLEUCHTE / WALL LAMP

FASSUNG / SOCKET:	1 X E 27/1 X E 26
BREITE / WIDTH:	136 MM / 5,3"
HÖHE / HEIGHT:	390 MM / 15,4"
AUSLADUNG / DISTANCE TO WALL:	125 MM / 5"
GLAS / GLASS:	NR285 OPAL MATT / OPAL FROSTED
LACKIERUNG / FINISH:	EISEN NATUR / IRON-NATURE
GEWICHT / WEIGHT:	3,5 KG





HL 2557

HL 2557

6-FL. HÄNGELEUCHE / 6-LIGHTER SUSPENSION LAMP

FASSUNG / SOCKET:

6 X E 27 / 6 X E 26

MIT / WITH DOWNLIGHTS:

3 X GU 10

DURCHMESSER / DIAMETER:

700 MM / 27,5"

HÖHE / HEIGHT:

270 MM / 10,5"

GLAS / GLASS:

NR285-OM

LACKIERUNG / FINISH:

EISEN NATUR / IRON-NATURE

GEWICHT / WEIGHT:

19 KG

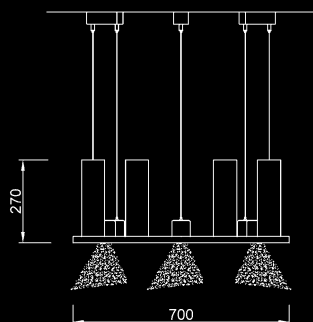



WL 3582



WL 3583

WL 3583
WANDLEUCHE / WALL LAMP

FASSUNG / SOCKET:	3 X E 27 / 3 X E 26
BREITE / WIDTH:	495 MM / 19,5"
HÖHE / HEIGHT:	630 MM / 25"
AUSLADUNG / DISTANCE TO WALL:	130 MM / 5"
GLAS / GLASS:	NR285 OPAL MATT / OPAL FROSTED
LACKIERUNG / FINISH:	EISEN NATUR / IRON-NATURE
GEWICHT / WEIGHT:	9,3 KG

WL 3582
WANDLEUCHE / WALL LAMP

FASSUNG / SOCKET:	1 X E 27 / 1 X E 26
BREITE / WIDTH:	125 MM / 5"
HÖHE / HEIGHT:	630 MM / 25"
AUSLADUNG / DISTANCE TO WALL:	130 MM / 5"
GLAS / GLASS:	NR285 OPAL MATT / OPAL FROSTED
LACKIERUNG / FINISH:	EISEN NATUR / IRON-NATURE
GEWICHT / WEIGHT:	3 KG



HL 2555

HL 2555

5-FL. HÄNGELEUCHE / 5-LIGHTER SUSPENSION LAMP

FASSUNG / SOCKET:	5 X E 27 / 5 X E 26
MIT / WITH 2 DOWNLIGHTS:	2 X GU 10
BREITE / WIDTH:	130 MM / 5"
HÖHE / HEIGHT:	268 MM / 10,5"
LÄNGE / LENGTH:	1275 MM / 49,5"
GLAS / GLASS:	NR285 OPAL MATT / OPAL FROSTED
LACKIERUNG / FINISH:	EISEN NATUR / IRON-NATURE
GEWICHT / WEIGHT:	14 KG

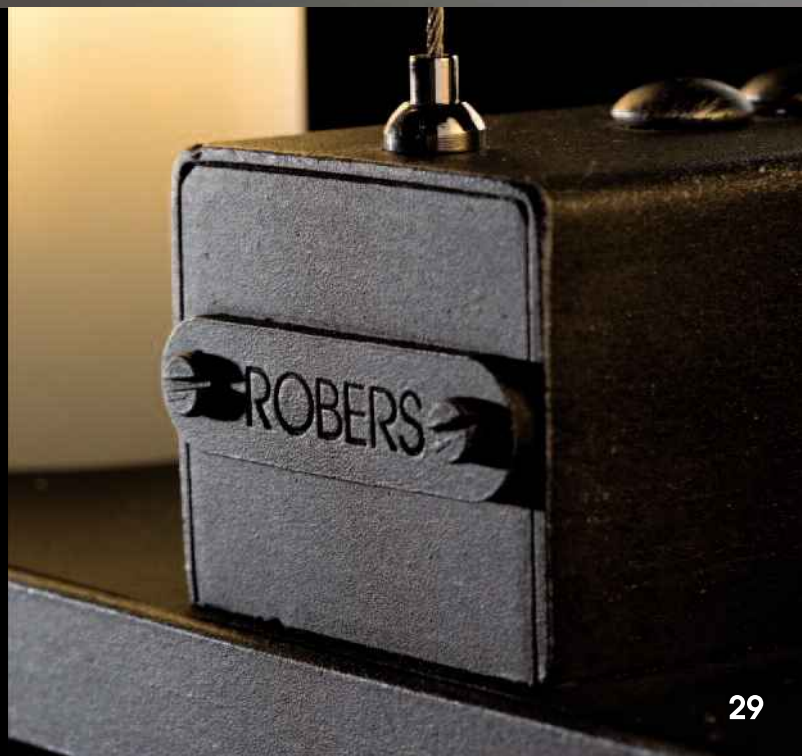
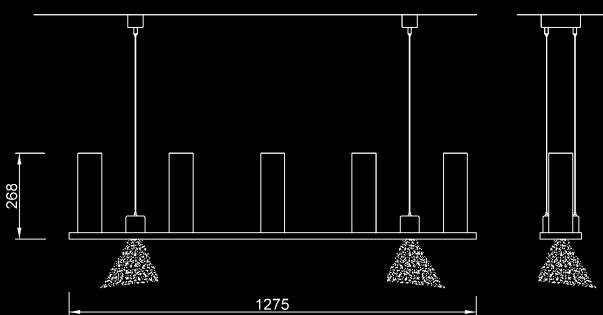



HL 2547



HL 2547

HL 2547

5-FL. HÄNGELEUCHE / 5-LIGHTER SUSPENSION LAMP

FASSUNG / SOCKET:	5 X E 27 / 5 X E 26
MIT / WITH DOWNLIGHTS:	3 X GU 10
BREITE / WIDTH:	100 MM / 4"
HÖHE / HEIGHT:	363 MM / 14"
LÄNGE / LENGTH:	1300 MM / 51"
GLAS / GLASS:	NR411 OPAL MATT / OPAL FROSTED
LACKIERUNG / FINISH:	EISEN NATUR / IRON-NATURE
GEWICHT / WEIGHT:	33 KG

DIE GESAMTHÖHE DER LEUCHE, INKLUSIVE AUFHÄNGUNG, WIRD IHREM WUNSCH ENTSPRECHEND GEFERTIGT.

THE OVER ALL HEIGHT OF THIS FIXTURE WILL BE MADE ACCORDING TO YOUR REQUIREMENTS.

LA HAUTEUR TOTALE DU LUMINAIRE, SYSTEME D'ATTACHE COMPRIS, SERA CONFECTIONNÉ SELON VOS SOUHAITS.



WL 3580

WL 3580

WANDLEUCHE / WALL LAMP

FASSUNG / SOCKET:	1 X E 27 / 1 X E 26
BREITE / WIDTH:	125 MM / 5"
HÖHE / HEIGHT:	700 MM / 27.5"
AUSLADUNG / DISTANCE TO WALL:	120 MM / 5"
GLAS / GLASS:	NR411 OPAL MATT / OPAL FROSTED
LACKIERUNG / FINISH:	EISEN NATUR / IRON-NATURE
GEWICHT / WEIGHT:	5.5 KG



WL 3581

WL 3581

WANDKERZENHALTER INKLUSIV ALTARKERZEN / WALL CANDLE STICK INCL. CHURCH CANDLES

BREITE / WIDTH:	720 MM / 28.3"
HÖHE / HEIGHT:	700 MM / 27.5"
AUSLADUNG / DISTANCE TO WALL:	100 MM / 4"
LACKIERUNG / FINISH:	EISEN NATUR / IRON-NATURE
GEWICHT / WEIGHT:	30 KG



B 8674



HL 2548

HL 2548

8-FL HÄNGELEUCHE / 8-LIGHTER SUSPENSION LAMP

FASSUNG / SOCKET:	8 X E 27 / 8 X E 26 + 4 X GU 10
DURCHMESSER / DIAMETER:	1000 MM / 39"
HÖHE / HEIGHT:	363 MM / 14"
GLAS / GLASS:	NR411 OPAL MATT / OPAL FROSTED
LACKIERUNG / FINISH:	EISEN NATUR / IRON-NATURE
GEWICHT / WEIGHT:	75 KG

DIE GESAMTHÖHE DER LEUCHE, INKLUSIVE AUFHÄNGUNG, WIRD IHREM WUNSCH ENTSPRECHEND GEFERTIGT. DIE LEUCHE KANN AUCH IN GRÖßEREN DURCHMESSERN ALS 1000MM GEFERTIGT WERDEN.

THE OVER ALL HEIGHT OF THIS FIXTURE WILL BE MADE ACCORDING TO YOUR REQUIREMENTS. IT IS ALSO POSSIBLE TO MAKE THIS FIXTURE BIGGER IN DIAMETER.

LA HAUTEUR TOTALE DU LUMINAIRE, SYSTEME D'ATTACHE COMPRIS, SERA CONFECTIONNÉ SELON VOS SOUHAITS. CE LUMINAIRE PEUT AUSSI ÊTRE FABRIQUÉ AVEC UN DIAMÈTRE SUPÉRIEUR À 1000MM.

B 8674 BLUMENAMPEL / FLOWER BOARD

BREITE / WIDTH:	125 MM/5"
HÖHE / HEIGHT:	1675 MM/66"
AUSLADUNG / DISTANCE TO WALL:	90 MM/3,5"
GLAS / GLASS:	NR449 KLAR
LACKIERUNG / FINISH:	EISEN ROSTIG / IRON-RUSTY
GEWICHT / WEIGHT:	11 KG





WL 3639



WL 3639

15-FL. WANDLEUCHE / 15-LIGHTER WALL LAMP

FASSUNG / SOCKET:	15 X E 27 / 15 X E 26
BREITE / WIDTH:	2065 MM / 81"
HÖHE / HEIGHT:	500 MM / 20"
AUSLADUNG / DISTANCE TO WALL:	185 MM / 7.3"
GLAS / GLASS:	4 X NR345-OM / 4 X NR346-OM / 7 X NR347-OM
LACKIERUNG / FINISH:	EISEN ROSTIG / IRON-RUSTY
GEWICHT / WEIGHT:	58 KG

HL 33.000.078-B

27-FL. HÄNGELEUCHE / 27-LIGHTER SUSPENSION LAMP

FASSUNG / SOCKET:	27 X E 27 / 27 X E 26 + 9 X GU 10
BREITE / WIDTH:	186 MM / 7"
HÖHE / HEIGHT:	320 MM / 12.5"
LÄNGE / LENGTH:	9000 MM / 355"
GLAS / GLASS:	9 X NR388-OM / 9 X NR346-OM / 9 X NR347-OM
OBERFLÄCHE / FINISH:	EISEN NATUR / IRON-NATURE
GEWICHT / WEIGHT:	318 KG

DIE GESAMTHÖHE DER LEUCHE, INKLUSIVE AUFHÄNGUNG, WIRD IHREM WUNSCH ENTSPRECHEND GEFERTIGT.
 THE OVER ALL HEIGHT OF THIS FIXTURE WILL BE MADE ACCORDING TO YOUR REQUIREMENTS.
 LA HAUTEUR TOTALE DU LUMINAIRE, SYSTEME D'ATTACHE COMPRIS, SERA CONFECTIONNÉ SELON VOS SOUHAITS.



33.000.078-B

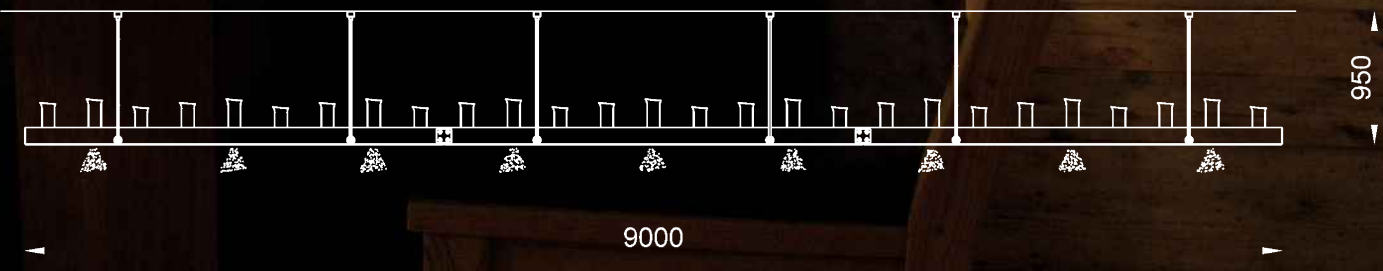
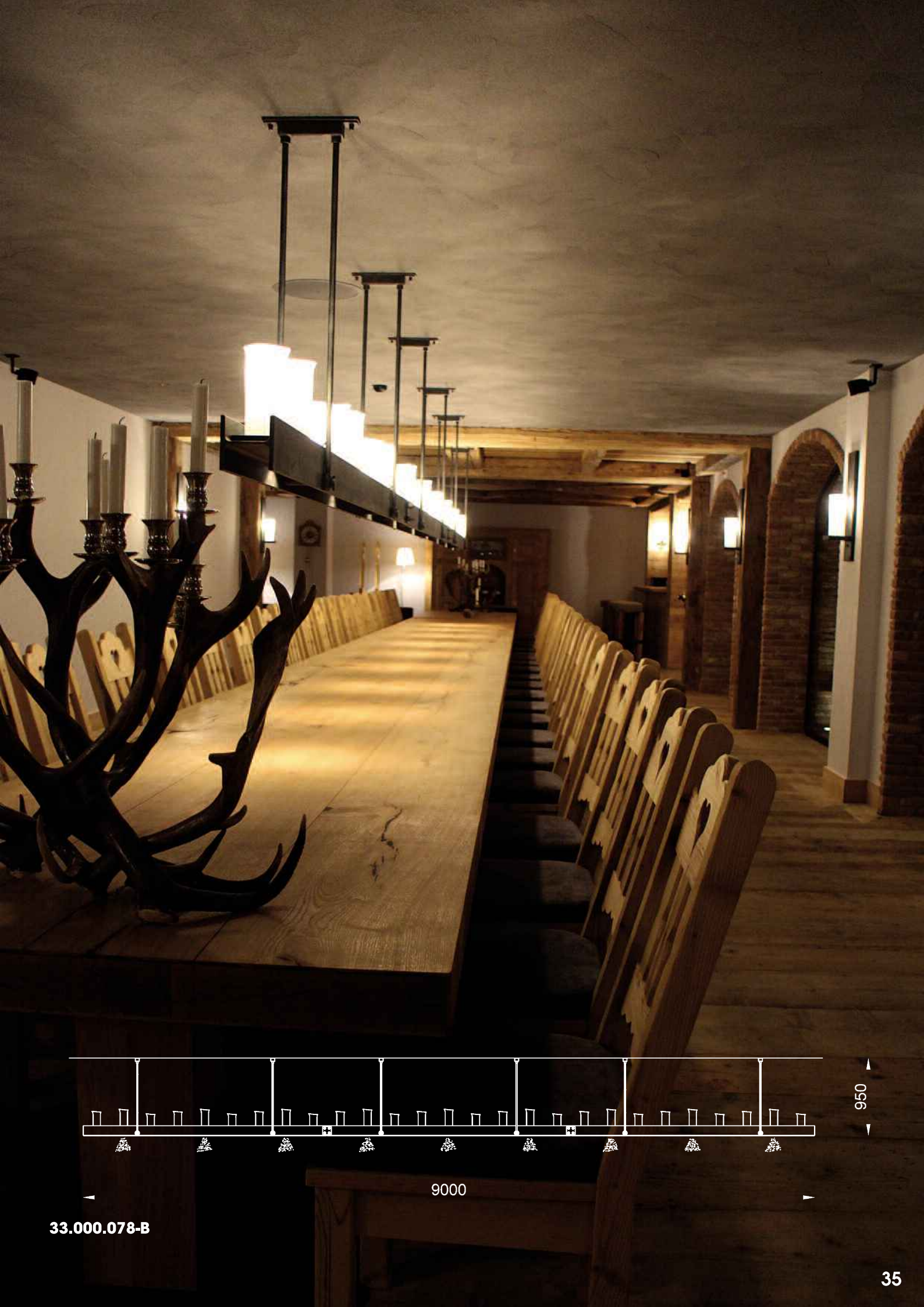

33.000.078-B



DE 2627

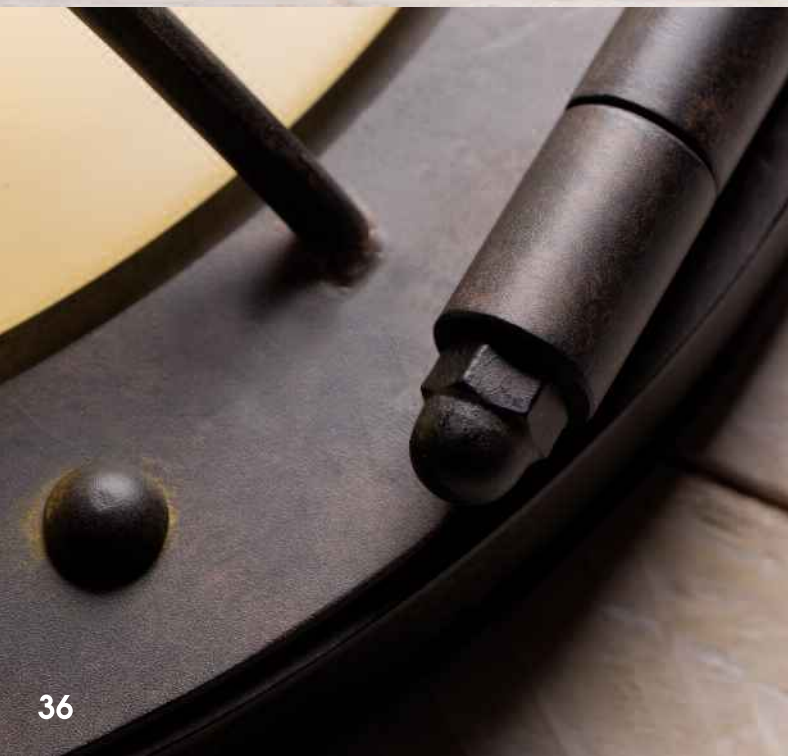

DE 2626 DECKENLEUCHTE / CEILING LAMP

OHNE ABBILDUNG / WITHOUT PICTURE

FASSUNG / SOCKET:	2 X E 27 / 2 X E 26
BREITE / WIDTH:	420 MM / 16,5"
HÖHE / HEIGHT:	120 MM / 5"
GLAS / GLASS:	NR320 OPALWEISS / OPAL WHITE
LACKIERUNG / FINISH:	TERRA
GEWICHT / WEIGHT:	10 KG

DE 2627 DECKENLEUCHTE / CEILING LAMP

FASSUNG / SOCKET:	3 X E 27 / 3 X E 26
BREITE / WIDTH:	540 MM / 21"
HÖHE / HEIGHT:	135 MM / 5"
GLAS / GLASS:	NR321 OPALWEISS / OPAL WHITE
LACKIERUNG / FINISH:	TERRA
GEWICHT / WEIGHT:	14,2 KG

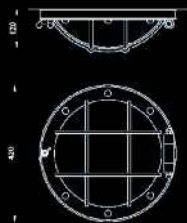

DE 2626

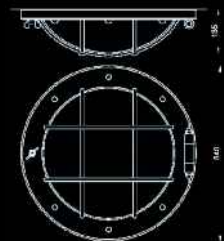

DE 2627



ST 2619

ST 2619
STRAHLER / SPOT

FASSUNG / SOCKET:	GU 10
BREITE / WIDTH:	130 MM / 5"
AUSLADUNG / DISTANCE TO WALL:	128 MM / 5"
HÖHE / HEIGHT:	130 MM / 5"
LACKIERUNG / FINISH:	EISEN NATUR / IRON-NATURE
GEWICHT / WEIGHT:	1,2 KG

ST 2615 STRAHLER / SPOT

FASSUNG / SOCKET:	GU 10
BREITE / WIDTH:	150 MM / 6"
HÖHE / HEIGHT:	90 MM / 3,5"
LACKIERUNG / FINISH:	EISEN NATUR / IRON-NATURE
GEWICHT / WEIGHT:	1 KG

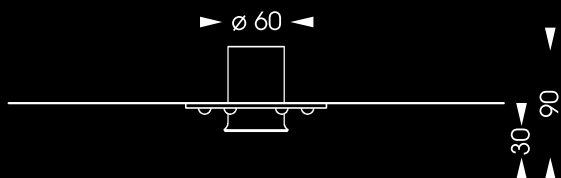

ST 2615



DE 2550



DE 2551



DE 2552

DE 2550 DECKENLEUCHTE / CEILING LAMP

FASSUNG / SOCKET: 2 X E 27 / 2 X E 26
HÖHE / HEIGHT: 120 MM / 5"
DURCHMESSER / DIAMETER: 420 MM / 16.5"
GLAS / GLASS: NR320 OPAL MATT / FROSTED
LACKIERUNG / FINISH: EISEN NATUR / IRON-NATURE
GEWICHT / WEIGHT: 8 KG

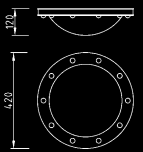

DE 2551 DECKENLEUCHTE / CEILING LAMP

FASSUNG / SOCKET: 3 X E 27 / 3 X E 26
HÖHE / HEIGHT: 135 MM / 5.5"
DURCHMESSER / DIAMETER: 540 MM / 21"
GLAS / GLASS: NR321 OPAL MATT / FROSTED
LACKIERUNG / FINISH: EISEN NATUR / IRON-NATURE
GEWICHT / WEIGHT: 10 KG

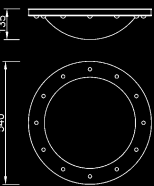

DE 2552 DECKENLEUCHTE / CEILING LAMP

FASSUNG / SOCKET: 3 X E 27 / 3 X E 26
HÖHE / HEIGHT: 155 MM / 6"
DURCHMESSER / DIAMETER: 730 MM / 29"
GLAS / GLASS: NR322 OPAL MATT / FROSTED
LACKIERUNG / FINISH: EISEN NATUR / IRON-NATURE
GEWICHT / WEIGHT: 14 KG

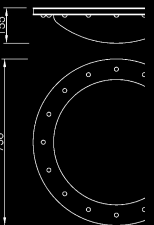

DE 2551
TERRA



ST 2628

ST 2628 STRAHLERLEISTE / SPOT RAIL

FASSUNG / SOCKET:	3 X E 27 / 3 X E 26
LÄNGE / LENGTH:	730 MM / 29"
BREITE / WIDTH:	150 MM / 6"
HÖHE / HEIGHT:	90 MM / 3,5"
LACKIERUNG / FINISH:	EISEN NATUR / IRON-NATURE
GEWICHT / WEIGHT:	8,4 KG

ST 2614 STRAHLER / SPOT

FASSUNG / SOCKET:	1 X E 27 / 1 X E 26
BREITE / WIDTH:	120 MM / 5"
HÖHE / HEIGHT:	200 MM / 8"
AUSLADUNG / DISTANCE TO WALL:	180 MM / 7"
LACKIERUNG / FINISH:	EISEN NATUR / IRON-NATURE
GEWICHT / WEIGHT:	2,2 KG

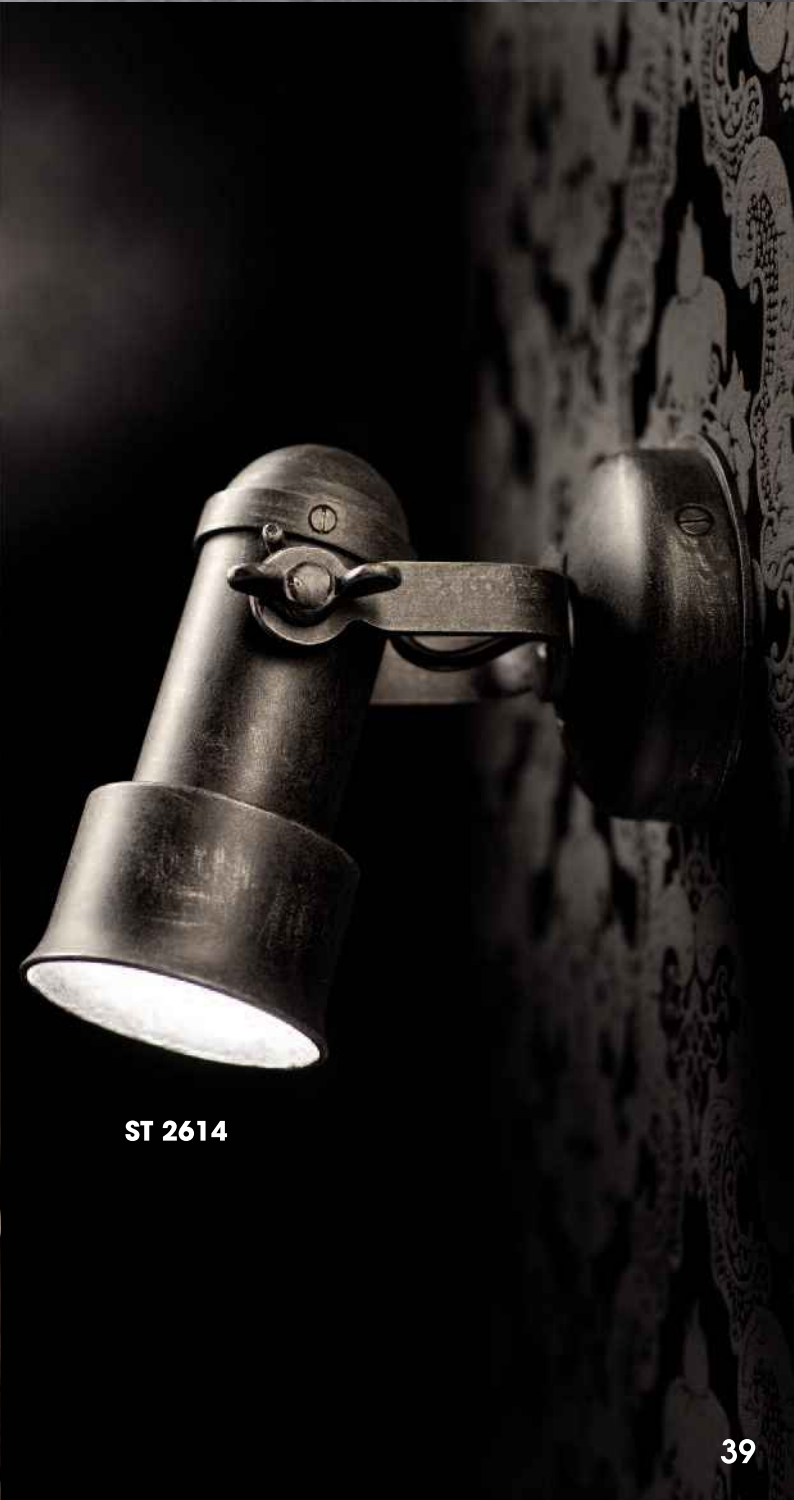

ST 2614

H 16930
SCHRANK / CABINET

BREITE / WIDTH: 900 MM / 35.5"
TIEFE / DEPTH: 500 MM / 20"
HÖHE / HEIGHT: 1260 MM / 50"
LACKIERUNG / FINISH: EISEN NATUR / IRON-NATURE
HOLZ / WOOD: EICHE GEÖLT / OILED OAK
GEWICHT / WEIGHT: 108 KG

H 16931
THEKE / COUNTER

LÄNGE / LENGTH: 1580 MM / 62"
BREITE / WIDTH: 830 MM / 33"
HÖHE / HEIGHT INCL. LEUCHTE / LAMP: 2280 MM / 90"
HÖHE THEKE / HEIGHT COUNTER: 1150 MM / 45"
LACKIERUNG / FINISH: EISEN NATUR / IRON-NATURE
HOLZ / WOOD: EICHE GEÖLT / OILED OAK
GEWICHT / WEIGHT: 200 KG

DIE ROBUSTE OPTIK DER MÖBEL IST GEWOLLT. AUFGRUND DES NATÜRLICHEN EICHENHOLZES ERGEBEN SICH UNGLEICHMÄSSIGKEITEN, DIE DEN CHARME DER MÖBEL AUSMACHEN.

BECAUSE WE WANT TO RECEIVE A VERY RUGGED LOOK WE USE REAL OAKWOOD. THEREFORE WE HAVE DIFFERENCES IN COLOUR AND SURFACES WHICH OF CAUSE MAKES THE CHARM OF IT.

L'UTILISATION DU CHÊNE DANS LA FABRICATION DE NOS MEUBLES LEUR APORTE SOLIDITÉ, ESTHÉTISME ET CHARME.



H 16931

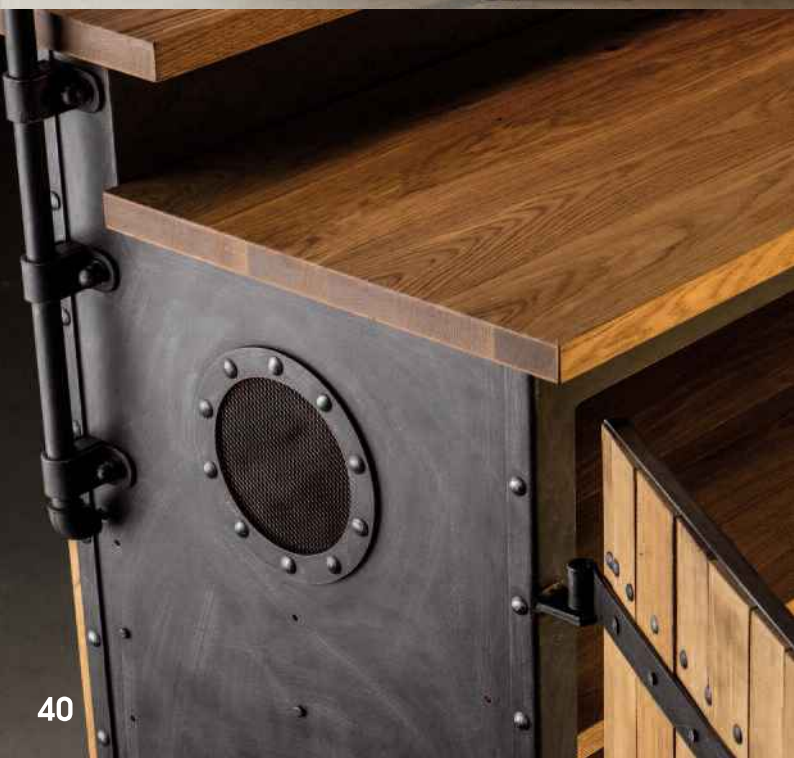



H 16930

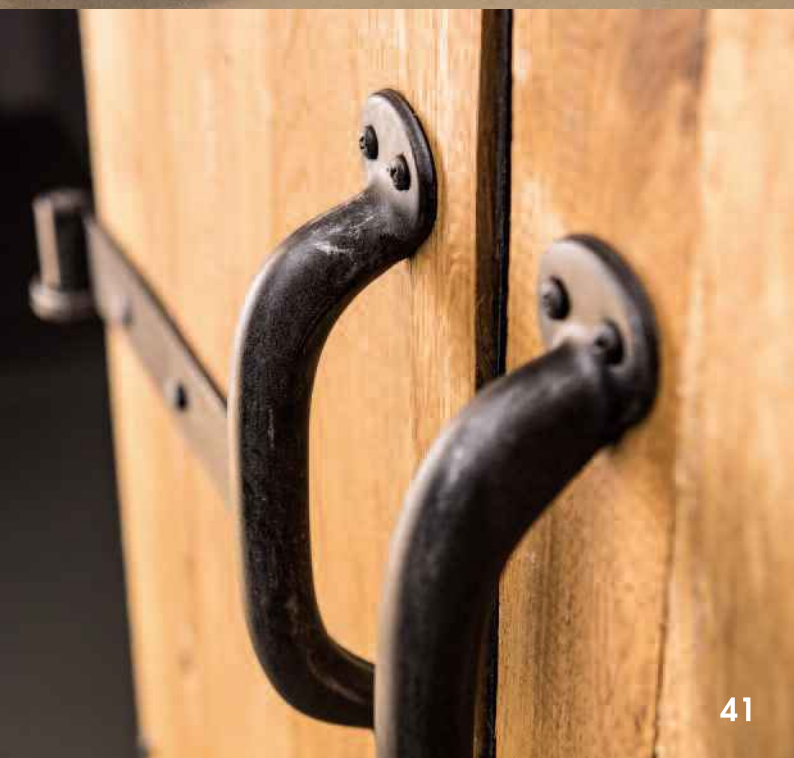



H 16928
COUCHTISCH / COFFEE TABLE

BREITE / WIDTH: 700 MM / 27.5"
HÖHE / HEIGHT: 400 MM / 16"
LÄNGE / LENGTH: 1200 MM / 47"
HOLZ / WOOD: EICHE GEÖLT / OILED OAK
LACKIERUNG / FINISH: TERRA
GEWICHT / WEIGHT: 60 KG



H 16928



H 16927

H 16927
COUCHTISCH / COFFEE TABLE

BREITE / WIDTH:

725 MM / 28,5"

HÖHE / HEIGHT:

513 MM / 20,5"

LÄNGE / LENGTH:

1225 MM / 48"

HOLZ / WOOD:

EICHE GEÖLT / OILED OAK

LACKIERUNG / FINISH:

OLD COPPER

GEWICHT / WEIGHT:

65 KG







H 16929

H 16929
SERVIERTISCH / WINE COUNTER

LÄNGE / LENGTH:	1200 MM / 47"
BREITE / WIDTH:	500 MM / 20"
HÖHE / HEIGHT:	1100 MM / 43,5"
LACKIERUNG / FINISH:	EISEN NATUR / IRON-NATURE
HOLZ / WOOD:	EICHE / OAK
GEWICHT / WEIGHT:	142 KG

AUF SEITE 44 SEHEN SIE EINEN NACH KUNDENWUNSCH VON UNS AUSGESTATTETEN WEINKELLER INKL. LED-BELEUCHTUNG.

ON PAGE 44 YOU SEE A WINE CELLAR WITH CUSTOM MADE EQUIPMENT FROM ROBERS INCL. LED BACKLIGHTING.

À LA PAGE 44, DÉCOUVREZ UNE CAVE À VIN RÉALISÉE SUR MESURE AVEC DU MOBILIER ROBERS INCLUANT UN SYSTÈME D'ÉCLAIRAGE À LED.





33.000.087-AI



33.000.087-BI



Le Bistrot Gourmand Luxembourg

LEUCHTEN IN SONDERANFERTIGUNGEN FÜR EIN RESTAURANT.

CUSTOM LIGHTING FIXTURES FOR A RESTAURANT.

LAMPES FAITS SUR MESURE POUR UN RESTAURANT.

33.000.087-AI

HÄNGELEUCHTE / SUSPENSION LAMP

FASSUNG / SOCKET:	1 X E 27 / 1 X E 26 + GU 10
DURCHMESSER / DIAMETER:	180 MM / 7"
HÖHE / HEIGHT:	900 MM / 35"
GLAS / GLASS:	1 X NR333-OM
OBERFLÄCHE / FINISH:	EISEN NATUR / IRON-NATURE

33.000.087-BI

WANDLEUCHTE / WALL LAMP

FASSUNG / SOCKET:	3 X E 27 / 3 X E 26
BREITE / WIDTH:	160 MM / 6,5"
HÖHE / HEIGHT:	1300 MM / 51"
AUSLADUNG / DISTANCE TO WALL:	180 MM / 7"
GLAS / GLASS:	3 X NR116-OM
OBERFLÄCHE / FINISH:	EISEN NATUR / IRON-NATURE





H 16922

H 16922
GLASTISCH / GLASS TABLE

BREITE / WIDTH:	500 MM / 20"
HÖHE / HEIGHT:	512 MM / 20,5"
LÄNGE / LENGTH:	980 MM / 38,5"
LACKIERUNG / FINISH:	EISEN NATUR / IRON-NATURE
GEWICHT / WEIGHT:	50 KG



H 16933

H 16933
TISCH MIT LEUCHTE / ILLUMINATED TABLE

FASSUNG / SOCKET:	1 X E 27 / 1 X E 26
LÄNGE / LENGTH:	800 MM / 31,5"
BREITE / WIDTH:	800 MM / 31,5"
HÖHE / HEIGHT INCL. LEUCHTE / LAMP:	1850 MM / 73"
HÖHE TISCH / HEIGHT TABLE:	760 MM / 30"
LACKIERUNG / FINISH:	EISEN NATUR / IRON-NATURE
HOLZ / WOOD:	EICHE GEÖLT / OILED OAK
GEWICHT / WEIGHT:	66 KG



KL 229



H 16932

H 16932
TISCH / TABLE

LÄNGE / LENGTH: 800 MM / 31,5"
BREITE / WIDTH: 800 MM / 31,5"
HÖHE / HEIGHT: 760 MM / 30"
LACKIERUNG / FINISH: EISEN NATUR / IRON-NATURE
HOLZ / WOOD: EICHE GEÖLT / OILED OAK
GEWICHT / WEIGHT: 54 KG

KL 229 KERZENLEUCHTER / CANDLE STICK

HÖHE / HEIGHT: 90 MM / 3,5"
DURCHMESSER / DIAMETER: 160 MM / 6"
LACKIERUNG / FINISH: EISEN NATUR / IRON-NATURE
GEWICHT / WEIGHT: 1 KG





DETAILS DER INNENEINRICHTUNG FÜR DAS CAFÉ RESTAURANT PRALINENMANUFAKTUR „TURMHAUS“ IN SÜDLOHN. LACKIERUNG EISEN NATUR

DETAILS FOR THE INTERIOR OF THE CAFÉ RESTAURANT CHOCOLATE MANUFACTORY „TURMHAUS“ IN SÜDLOHN-GERMANY. FINISH: IRON-NATURE

DÉTAILS DE L'INTÉRIEUR DU CAFÉ-RESTAURANT ET MANUFACTURE DE CHOCOLAT « TURMHAUS » À SUDLOHN. FINITION EISEN-NATUR

WWW.TURMHAUS.COM

TREPPENGELÄNDER UND HÄNGELEUCHE FÜR DAS AUSFLUGSLOKAL RESTAURANT „HAARMÜHLE“ IN AHAUS.

BANISTER AND SUSPENSION LAMP FOR THE POPULAR RESTAURANT „HAARMÜHLE“ IN AHAUS-GERMANY.

BALUSTRADE ET LAMPE DE SUSPENSION POUR LE POPULAIRE RESTAURANT « HAARMUEHLE » À AHAUS EN ALLEMAGNE.

WWW.HAARMUEHLE.DE







GARDEROBE 8.883.000



B 8702

GARDEROBE / WARDROBE

ABMESSUNGEN NACH KUNDENWUNSCH.
DIMENSIONS UPON REQUEST.
DIMENSION FAIT SUR MESURE.

B 8702

SCHIRMSTÄNDER/UMBRELLA STAND

BREITE / WIDTH:	308 MM / 12"
HÖHE / HEIGHT:	565 MM / 22"
LACKIERUNG / FINISH:	EISEN NATUR / IRON NATURE
GEWICHT / WEIGHT:	14,2 KG

B 8708

GROSSE WANDUHR / BIG WALL CLOCK

BREITE / WIDTH:	960 MM / 38"
HÖHE / HEIGHT:	960 MM / 38"
AUSLADUNG / DISTANCE TO WALL:	32 MM / 1,5"
LACKIERUNG / FINISH:	EISEN ROSTIG / IRON-RUSTY
GEWICHT / WEIGHT:	16,2 KG





B 8708

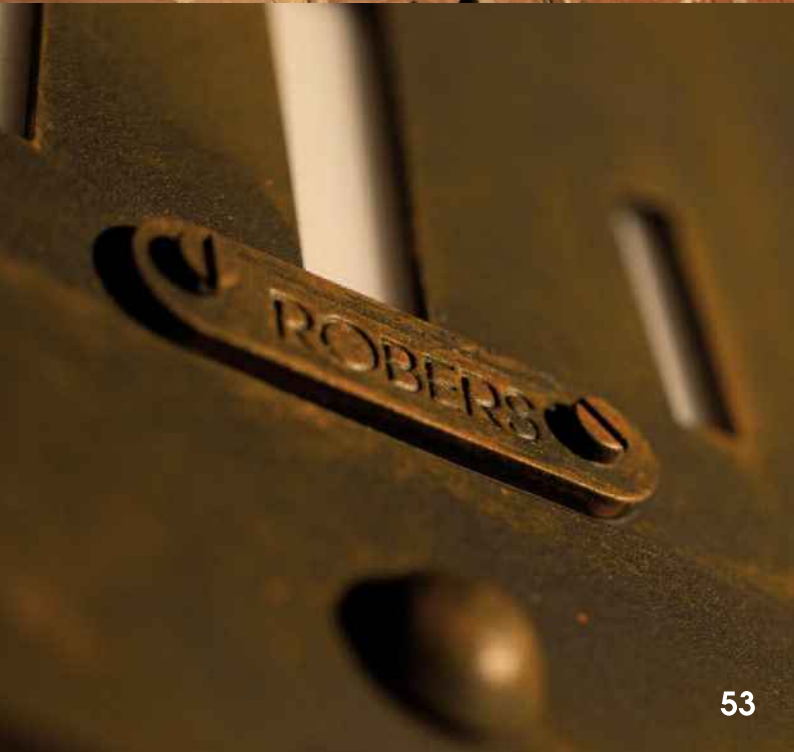



111.000.260
AQUARIUM

BREITE / WIDTH:	1000 MM / 39.5"
HÖHE / HEIGHT:	2600 MM / 102.5"
TIEFE / DEPTH:	700 MM / 27.5"
BECKEN / POOL:	2
VOLUMEN / VOLUME:	2 X 300 L / 2 X 52.8 GAL
LICHT / LIGHT:	LED-TAGESLICHTSIMULATOR / LED-DAY LIGHT SIMULATOR
LACKIERUNG / FINISH:	EISEN NATUR / IRON-NATURE
GEWICHT WIE ABGEBILDET INKL. WASSER / WEIGHT AS SHOWN IN CATALOGUE INCL. WATER:	CA. 1200 KG

UNSERE AQUARIEN WERDEN AUF MASS GEFERTIGT. WIR RICHTEN UNS NACH IHREN WÜNSCHEN.

OUR AQUARIUM IS CUSTOM MADE. MEANS WE CAN BUILT THE SIZE UPON YOUR REQUEST.

NOUS FAISON NOTRE AQUARIUM SUR MEASURE.





OUTDOOR



AL 6826



AL 6826
POLLERLEUCHE / POST LAMP

FASSUNG / SOCKET:
WATZAHL / WATTAGE:
BREITE / WIDTH:
HÖHE / HEIGHT:
LACKIERUNG / FINISH:
GEWICHT / WEIGHT:

1 X E 27 / 1 X E 26
6 W LED
710 MM / 28"
1215 MM / 48"
TERRA
32 KG



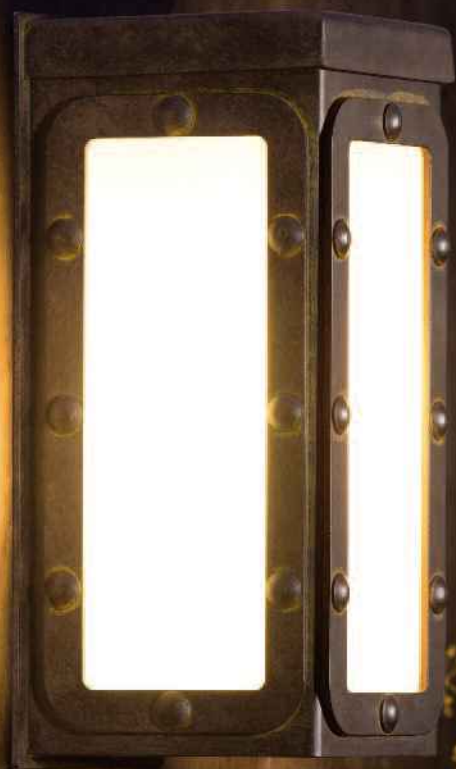

WL 3636

WL 3636
WANDLEUCHE / WALL LAMP

FASSUNG / SOCKET: 1 X E 27 / 1 X E 26
 BREITE / WIDTH: 158 MM / 6,2"
 HÖHE / HEIGHT: 345 MM / 13,5"
 AUSLADUNG / DISTANCE TO WALL: 151 MM / 6"
 LACKIERUNG / FINISH: TERRA
 GEWICHT / WEIGHT: 6,8 KG

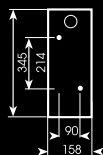

AL 6833
POLLERLEUCHE / POST LAMP

FASSUNG / SOCKET: 1 X E 27 / 1 X E 26
 BREITE / WIDTH: 160 MM / 6,5"
 HÖHE / HEIGHT: 1000 MM / 39"
 LACKIERUNG / FINISH: TERRA
 GEWICHT / WEIGHT: 18,4 KG

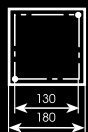

AL 6833



AL 6789

AL 6789

SOCKELLEUCHE / PEDESTAL LAMP
DECKENLEUCHE / CEILING LAMP

FASSUNG / SOCKET: 1 X E 27 / 1 X E 26
BREITE / WIDTH: 160 MM / 6"
HÖHE / HEIGHT: 350 MM / 14"
GLAS / GLASS: NR447 AUSSEN MATTIERT / OUTSIDE FROSTED
LACKIERUNG / FINISH: EISEN NATUR / IRON-NATURE
GEWICHT / WEIGHT: 6 KG



AL 6790 POLLERLEUCHE / POST LAMP

FASSUNG / SOCKET: 1 X E 27 / 1 X E 26
BREITE / WIDTH: 160 MM / 6"
HÖHE / HEIGHT: 1100 MM / 43"
GLAS / GLASS: NR447 AUSSEN MATTIERT / OUTSIDE FROSTED
LACKIERUNG / FINISH: EISEN NATUR / IRON-NATURE
GEWICHT / WEIGHT: 13 KG



AL 6790



AL 6789





WL 3630

WL 3630
WANDLEUCHTE / WALL LAMP

FASSUNG / SOCKET: 1 X E 27 / 1 X E 26
 BREITE / WIDTH: 160 MM / 6"
 HÖHE / HEIGHT: 500 MM / 20"
 AUSLADUNG / DISTANCE TO WALL: 180 MM / 7"
 GLAS / GLASS: NR285 OPALWEISS / OPAL WHITE
 LACKIERUNG / FINISH: EISEN NATUR / IRON-NATURE
 GEWICHT / WEIGHT: 9,6 KG

AL 6824
POLLERLEUCHTE / POST LAMP

FASSUNG / SOCKET: 1 X E 27 / 1 X E 26
 LÄNGE / LENGTH: 240 MM / 9,5"
 BREITE / WIDTH: 180 MM / 7"
 HÖHE / HEIGHT: 1100 MM / 43"
 GLAS / GLASS: NR285 OPALWEISS / OPAL WHITE
 LACKIERUNG / FINISH: EISEN NATUR / IRON-NATURE
 GEWICHT / WEIGHT: 17 KG

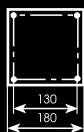

AL 6824



AL 6339



WL 3634

WL 3634
WANDLEUCHTE / WALL LAMP

FASSUNG / SOCKET:	INCL. 1 X LED-MODUL 4,3 W
BREITE / WIDTH:	140 MM / 5,5"
HÖHE / HEIGHT:	172 MM / 6,5"
AUSLADUNG / DISTANCE TO WALL:	288 MM / 11,5"
LACKIERUNG / FINISH:	EISEN ROSTIG / IRON-RUSTY
GEWICHT / WEIGHT:	6 KG

AL 6829
POLLERLEUCHTE / POST LAMP

FASSUNG / SOCKET:	INCL. 1 X LED-MODUL 4,3W
BREITE / WIDTH:	410 MM / 16"
HÖHE / HEIGHT:	1115 MM / 44"
LACKIERUNG / FINISH:	EISEN ROSTIG / IRON-RUSTY
GEWICHT / WEIGHT:	25,2 KG



AL 6339
POLLERLEUCHTE / POST LAMP

FASSUNG / SOCKET:	1 X E 27 / 1 X E 26
BREITE / WIDTH:	400 MM / 16"
HÖHE / HEIGHT:	1060 MM / 42"
MACROLONZYLINDER:	Z 527 KLAR / CLEAR
LACKIERUNG / FINISH:	EISEN NATUR / IRON-NATURE
GEWICHT / WEIGHT:	15 KG



AL 6829

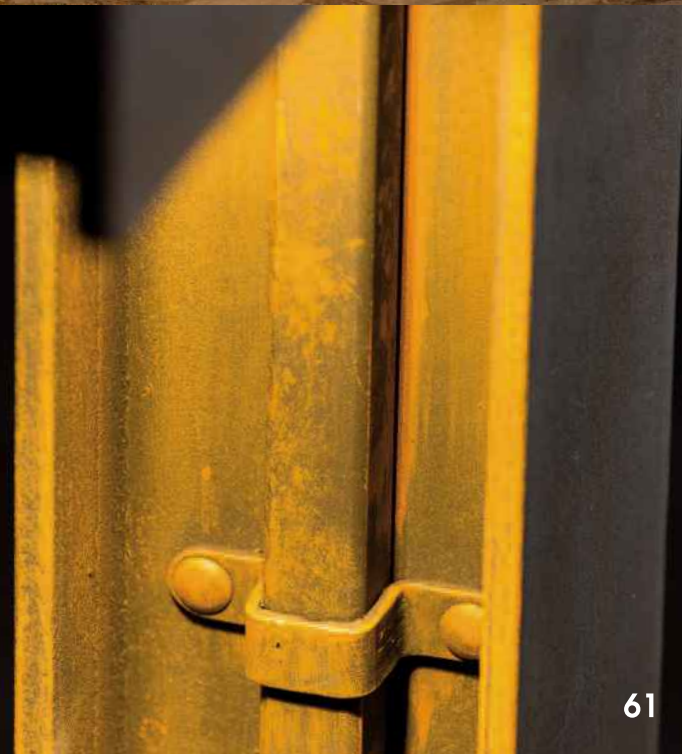

AL 6828 SOCKELLEUCHE / PEDESTAL LAMP

FASSUNG / SOCKET: 1 X E 27 / 1 X E 26
BREITE / WIDTH: 170 MM / 6,5"
HÖHE / HEIGHT: 365 MM / 14,5"
GLAS / GLASS: NR347 OPAL MATT / OPAL FROSTED
LACKIERUNG / FINISH: EISEN NATUR / IRON-NATURE
GEWICHT / WEIGHT: 15 KG

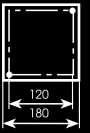

AL 6832 POLLERLEUCHE / POST LAMP

FASSUNG / SOCKET: 1 X E 27 / 1 X E 26
BREITE / WIDTH: 170 MM / 6,5"
HÖHE / HEIGHT: 1100 MM / 43"
GLAS / GLASS: NR347 OPAL MATT / OPAL FROSTED
LACKIERUNG / FINISH: EISEN NATUR / IRON-NATURE
GEWICHT / WEIGHT: 20 KG

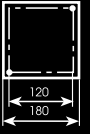

WL 3632-ST WANDLEUCHE / WALL LAMP

FASSUNG / SOCKET: 1 X E 27 / 1 X E 26 + GU 10
BREITE / WIDTH: 236 MM / 9,5"
HÖHE / HEIGHT: 400 MM / 16"
AUSLADUNG / DISTANCE TO WALL: 218 MM / 8,5"
GLAS / GLASS: NR347 OPAL MATT / OPAL FROSTED
LACKIERUNG / FINISH: EISEN NATUR / IRON-NATURE
GEWICHT / WEIGHT: 12,5 KG



AL 6828



WL 3632-ST



AL 6832



AL 6788

AL 6788
POLLERLEUCHTE / POST LAMP

FASSUNG / SOCKET:
 WATZAHL / WATTAGE:
 BREITE / WIDTH:
 HÖHE / HEIGHT:
 GLAS / GLASS:
 LACKIERUNG / FINISH:
 GEWICHT / WEIGHT:

1 X 2 G 11
 DULUX 24 W
 170 MM / 6.7"
 860 MM / 34"
 NR303 OPAL
 EISEN NATUR / IRON-NATURE
 19 KG

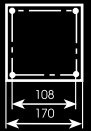

AL 6825
STECKDOSENPOLLER / BOLLARD WITH RECEPTACLES

BREITE / WIDTH:
 HÖHE / HEIGHT:
 LACKIERUNG / FINISH:
 GEWICHT / WEIGHT:

180 MM / 7"
 500 MM / 19.5"
 EISEN NATUR / IRON-NATURE
 8,2 KG

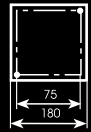

B 8709
HAUSNUMMER / HOUSE NUMBER

BREITE / WIDTH:
 HÖHE / HEIGHT:
 LACKIERUNG / FINISH:
 GEWICHT / WEIGHT:

300 MM / 11.8"
 170 MM / 6.7"
 EISEN NATUR / IRON-NATURE
 1,5 KG

BEI BESTELLUNG BITTE DIE GEWÜNSCHTE NUMMER ANGEBEN.
 PLEASE GIVE US YOUR REQUESTED NO. WITH ORDER.
 VEUILLEZ NOUS NOTIFIER LE NUMERO SOUHAITE LORS DE LA COMMANDE.



B 8709



AL 6825



**AL 6825
 OPEN**



WL 3586

WL 3586
WANDLEUCHTE / WALL LAMP

WATZAHL / WATTAGE: LED 4,3 W MIT OPTIK 20° / WITH 20° OPTICS
 BREITE / WIDTH: 120 MM / 5"
 HÖHE / HEIGHT: 780 MM / 30,5"
 AUSLADUNG / DISTANCE TO WALL: 120 MM / 4,5"
 LACKIERUNG / FINISH: EISEN NATUR / IRON-NATURE
 GEWICHT / WEIGHT: 11 KG

AL 6770
POLLERLEUCHTEN / POST LAMP

WATZAHL / WATTAGE: LED 4,3 W MIT OPTIK 20° / WITH 20° OPTICS
 BREITE / WIDTH: 120 MM / 5"
 HÖHE / HEIGHT: 1005 MM / 39,5"
 LACKIERUNG / FINISH: EISEN NATUR / IRON-NATURE
 GEWICHT / WEIGHT: 13KG

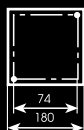

AL 6770



WL 3437



WL 3592

WL 3437 WANDLEUCHE / WALL LAMP

FASSUNG / SOCKET:	1 X E 27 / 1 X E 26
BREITE / WIDTH:	310 MM / 12"
HÖHE / HEIGHT:	500 MM / 20"
AUSLADUNG / DISTANCE TO WALL:	700 MM / 28"
LACKIERUNG / FINISH:	PATINA
GEWICHT / WEIGHT:	5 KG



WL 3592 WANDLEUCHE / WALL LAMP

FASSUNG / SOCKET:	1 X E 27 / 1 X E 26
BREITE / WIDTH:	910 MM / 36"
HÖHE / HEIGHT:	890 MM / 35"
AUSLADUNG / DISTANCE TO WALL:	1450 MM / 57"
DURCHMESSER SCHIRM / DIAMETER SHADE:	500 MM / 20"
LACKIERUNG / FINISH:	EISEN NATUR / IRON NATURE
GEWICHT / WEIGHT:	25 KG

AL 6792 STÄNDERLEUCHE / POST LAMP

FASSUNG / SOCKET:	1 X E 27 / 1 X E 26
BREITE / WIDTH:	1780 MM / 70"
HÖHE / HEIGHT:	2220 MM / 87.4"
LACKIERUNG / FINISH:	EISEN NATUR / IRON-NATURE
GEWICHT / WEIGHT:	39 KG



WL 3592

AL 6792





WL 3638

WL 3638
WANDLEUCHE / WALL LAMP

FASSUNG / SOCKET:
BREITE / WIDTH:
HÖHE / HEIGHT:
AUSLADUNG / DISTANCE TO WALL:
LACKIERUNG / FINISH:
GEWICHT / WEIGHT:

1 X E 27 / 1 X E 26
400 MM / 16"
420 MM / 16.5"
750 MM / 29.5"
OLD BLACK
9 KG

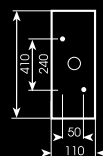

AL 6835

AL 6778-N
STÄNDERLEUCHE / POST LAMP

FASSUNG / SOCKET:
BREITE / WIDTH:
HÖHE / HEIGHT:
LACKIERUNG / FINISH:
GEWICHT / WEIGHT:

1 X E 27 / 1 X E 26
800 MM / 31.5"
2850 MM / 112"
OLD BLACK
31 KG



AL 6835
2-FL. STÄNDERLEUCHE / 2-LIGHTER POST LAMP

FASSUNG / SOCKET:
BREITE / WIDTH:
HÖHE / HEIGHT:
LACKIERUNG / FINISH:
GEWICHT / WEIGHT:

2 X E 27 / 2 X E 26
1600 MM / 63"
2850 MM / 112"
OLD BLACK
36 KG

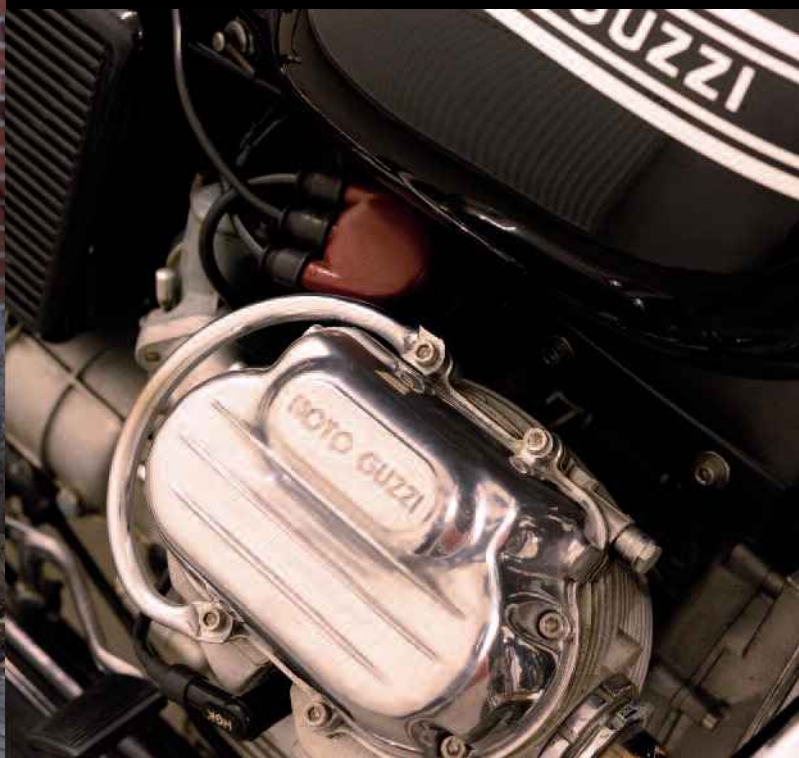



AL 6778-N



AL 6823

AL 6823
 POLLERLEUCHTE MIT STRAHLER /
 POST LAMP WITH SPOT

FASSUNG / SOCKET: 1 X E 27 / 1 X E 26
 SPOT: GU 10 LED
 BREITE / WIDTH: 200 MM / 8"
 HÖHE / HEIGHT: 420 MM / 16.5"
 GLAS / GLASS: NR124 OPALWEISS / OPAL WHITE
 LACKIERUNG / FINISH: EISEN NATUR / IRON-NATURE
 GEWICHT / WEIGHT: 5,2 KG



AL 6774
 LED STRAHLER 2-FLAMMIG /
 2-LIGHTER LED SPOT

SPOT: ALUMINIUMGUSS / CAST ALUMINIUM
 T-TRÄGER / I-BEAM: STAHL, FEUERVERZINKT /
 STEEL HOT DIP GALVANIZED
 SPOT: 2 X GU 10 LED
 BREITE / WIDTH: 510 MM / 20"
 HÖHE / HEIGHT: 1100 MM / 43"
 LACKIERUNG / FINISH: EISEN NATUR / IRON-NATURE
 GEWICHT / WEIGHT: 32 KG

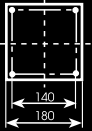

AL 6774



AL 6772

AL 6772

LED-STRAHLER / LED SPOT

SPOT:	ALUMINIUMGUSS / CAST ALUMINIUM
SOCKEL / POST:	STAHL, FEUERVERZINKT / STEEL HOT DIP GALVANIZED
SPOT:	GU 10 LED
BREITE / WIDTH:	138 MM / 5.5 INCH
LÄNGE / LENGTH:	160 MM / 6 INCH
HÖHE / HEIGHT:	260 MM / 10 INCH
LACKIERUNG / FINISH:	EISEN NATUR / IRON-NATURE
GEWICHT / WEIGHT:	3 KG



AL 6772



WL 3635

WL 3635 WANDLEUCHE / WALL LAMP

FASSUNG / SOCKET: 1 X E 27 / 1 X E 26
BREITE / WIDTH: 400 MM / 16"
HÖHE / HEIGHT: 532 MM / 21"
AUSLADUNG / DISTANCE TO WALL: 845 MM / 33"
GLAS / GLASS: NR444 OPAL WEISS / OPAL WHITE
LACKIERUNG / FINISH: OLD COPPER
GEWICHT / WEIGHT: 13 KG

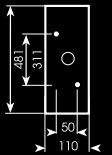

AL 6831 STÄNDERLEUCHE / POST LAMP

FASSUNG / SOCKET: 1 X E 27 / 1 X E 26
BREITE / WIDTH: 844 MM / 33"
HÖHE / HEIGHT: 3020 MM / 119"
GLAS / GLASS: NR444 OPAL WEISS / OPAL WHITE
LACKIERUNG / FINISH: OLD COPPER
GEWICHT / WEIGHT: 35 KG

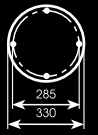

HL 2625 HÄNGELEUCHE / SUSPENSION LAMP

FASSUNG / SOCKET: 1 X E 27 / 1 X E 26
BREITE / WIDTH: 400 MM / 16"
HÖHE / HEIGHT: 364 MM / 14,5"
Ø BALDACHIN / Ø CANOPY: 160 MM / 6,5"
GLAS / GLASS: NR444 OPAL WEISS / OPAL WHITE
LACKIERUNG / FINISH: OLD COPPER
GEWICHT / WEIGHT: 8,5 KG



HL 2625





AL 6831



WL 3637



WL 3637 WANDLEUCHTE / WALL LAMP

WATZAHL / WATTAGE: LED-MODUL 35 W, 3000 K, 2700 LM BEI 700 MA
 BREITE / WIDTH: 270 MM / 10,5"
 AUSLADUNG / DISTANCE TO WALL: 800 MM / 31,5"
 HÖHE / HEIGHT: 386 MM / 15"
 LACKIERUNG / FINISH: EISEN NATUR / IRON-NATURE
 GEWICHT / WEIGHT: 24 KG

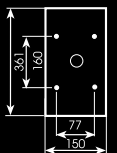

AL 6771-N STÄNDERLEUCHTE / POST LAMP

WATZAHL / WATTAGE: LED-MODUL 35 W, 3000 K, 2700 LM BEI 700 MA
 BREITE / WIDTH: 270 MM / 10,5"
 AUSLADUNG / DISTANCE TO WALL: 2045 MM / 80,5"
 HÖHE / HEIGHT: 4850 MM / 190"
 LACKIERUNG / FINISH: EISEN NATUR / IRON-NATURE
 GEWICHT / WEIGHT: 62 KG

MAST MIT INTEGRIERTEM ERDSTÜCK - FALLS EINE BODENPLATTE GEWÜNSCHT WIRD, BITTE ANGEBEN.

POLE WITH INTEGRATED EARTHPIECE, IF BASEPLATE NEEDED PLEASE LET US KNOW.

MAT AVEC FONDATION INTEGREE, LIVRE AVE PLATINE DE FIXATION SUR DEMANDE.



AL 6771-N



PB 1148

PB 1148
BANK / BENCH

TIEFE / DEPTH:	520 MM / 20.5"
LÄNGE / LENGTH:	2057 MM / 81"
HÖHE / HEIGHT:	500 MM / 20"
LACKIERUNG / FINISH:	EISEN NATUR / IRON-NATURE
GEWICHT / WEIGHT:	47 KG

B 8707
PFLANZKÜBEL / BUCKET FOR PLANTS

TIEFE / DEPTH:	600 MM / 24"
LÄNGE / LENGTH:	690 MM / 27"
HÖHE / HEIGHT:	634 MM / 25"
LACKIERUNG / FINISH:	TERRA
GEWICHT / WEIGHT:	47 KG

AL 6834
STÄNDERLEUCHE / POST LAMP

FASSUNG / SOCKET:	2 X E 27 / 2 X E 26
BREITE / WIDTH:	890 MM / 35"
HÖHE / HEIGHT:	2500 MM / 98"
TIEFE / DEPTH:	440 MM / 17.3"
LACKIERUNG / FINISH:	OLD COPPER + EISEN ROSTIG + MESSING ANTIK / OLD COPPER + IRON-RUSTY + BRASS ANTIQUE
GLAS / GLASS:	NR141 + NR 285 KLAR / CLEAR
GEWICHT / WEIGHT:	118 KG



B 8707





AL 6834

440
300



723
590

A black metal tripod fire pit stands in a snowy forest. The fire pit has a large, shallow, bowl-shaped base containing a fire of logs. A circular metal grate is suspended from the top of the tripod by three chains. The background shows snow-covered ground and dark, snow-dusted trees.

**B 8675 mit
B 8675-R**



B 8680

B 8675
FEUERSCHALE / FIREPLACE

DURCHMESSER / DIAMETER: 1050 MM / 41"
HÖHE / HEIGHT: 400 MM / 15,5"
GEWICHT / WEIGHT: 52 KG

B 8680
FEUERSCHALE / FIREPLACE

DURCHMESSER / DIAMETER: 800 MM / 31,5"
HÖHE / HEIGHT: 300 MM / 12"
GEWICHT / WEIGHT: 34 KG

B 8675-R
GESTELL / RACK

WIRD AUFGESTECKT, FÜR BEIDE FEUERSTELLEN PASSEND
RACK TO BE PUT ON THE I-BEAM, MATCHING FOR BOTH FIREPLACES

HÖHE / HEIGHT: CA. 2150 MM / 85"
GEWICHT / WEIGHT: 18 KG





SONDERLEUCHTEN FÜR DIE FIRMA „THUNDERBIKE“
IN HAMMINKELN.

CUSTOM MADE LIGHTING FIXTURES FOR
„THUNDERBIKE“ IN HAMMINKELN, GERMANY.

LAMPES FAITS SUR MESURE POUR „THUNDERBIKE“
ALEMAGNE

WWW.THUNDERBIKE.DE

WL 3593

WANDLEUCHE / WALL LAMP

FASSUNG / SOCKET:	1 X E 27 / 1 X E 26
BREITE / WIDTH:	160 MM / 6"
HÖHE / HEIGHT:	355 MM / 14"
AUSLADUNG / DISTANCE TO WALL:	375 MM / 15"
LACKIERUNG / FINISH:	OLD BLACK



WL 3591

WANDLEUCHE / WALL LAMP

FASSUNG / SOCKET:	1 X E 27 / 1 X E 26
BREITE / WIDTH:	280 MM / 11"
HÖHE / HEIGHT:	490 MM / 19,3"
AUSLADUNG / DISTANCE TO WALL:	735 MM / 29"
LACKIERUNG / FINISH:	OLD BLACK





WL 3591



HL 2568



WL 3593

OBERFLÄCHEN COLOURS



EISEN NATUR / IRON NATURE



PATINA



EISEN ROSTIG / IRON-RUSTY



TERRA



OLD-COPPER



MESSING ANTIK / BRASS ANTIQUE



OLD-BRONZE



ANTI-K-GRÜN / ANTIQUE-GREEN



SCHWARZ-SILBER / BLACK-SILVER



OLD BLACK

ALLE LEUCHTEN WERDEN VON HAND LACKIERT, LEICHTE FARBABWEICHUNGEN SIND DAHER MÖGLICH. SELBST-
VERSTÄNDLICH KÖNNEN DIE LEUCHTEN AUCH IN JEDER RAL-FARBE LACKIERT WERDEN.

THE FINAL FINISH IS MADE BY HAND, THEREFORE SLIGHT COLOUR DIFFERENCES ARE POSSIBLE.
OF COURSE ALSO EVERY RAL COLOUR IS POSSIBLE.

TOUTES LES PATINES DE FINITION SONT PEINTES A LA MAIN, C'EST POURQUOI DE LEGERES NUANCES DE TEINTE
SONT POSSIBLES. TOUTES LES COULEURS RAL SONT EGALEMENT REALISABLES.

INHALTSVERZEICHNIS INDEX

STÄNDERLEUCHTEN POST LAMPS

AL6339	60
AL6770	65
AL6771-N	75
AL6772	71
AL6774	70
AL6778-N	69
AL6788	64
AL6789	58
AL6790	58
AL6792	67
AL6823	70
AL6824	59
AL6825	64
AL6826	55/56
AL6828	62
AL6829	61
AL6831	73
AL6832	63
AL6833	57
AL6834	77
AL6835	68

ACCESSOIRES ACCESSORIES

B8674	32
B8675	78
B8675-R	78
B8680	79
B8702	52
B8707	76
B8708	53
B8709	64
8.883.000	52
111.000.260	54

DECKENLEUCHTEN CEILING LAMPS

AL6789	58
DE2550	38
DE2551	38
DE2552	38
DE 2626	36
DE 2627	36

TISCHE/MÖBEL TABLES/FURNITURE

H16922	48
H16927	43
H16928	42
H16929	45
H16930	41
H16931	40
H16932	49
H16933	48

HÄNGELEUCHTEN SUSPENSION LAMPS

HL2509	22
HL2547	30/31
HL2548	33
HL2555	29
HL2557	26/27
HL2560	20/21
HL2569-400	18/19
HL2569-500	18
HL2609	15
HL2610	6
HL2620	10
HL2621	13
HL2623	9
HL2624	17
HL2625	72
33.000.078-B	34/35
33.000.087-A1	47

PARKBANK BENCH

PB1148	76
--------	----

STEHLEUCHTEN FLOOR LAMPS

SL105	24
SL106	14
SL107	16
SL108	11
SL109	7
SL110	12

STRAHLER SPOTS

ST2614	39
ST2615	37
ST2619	37
ST2628	39

TISCHLEUCHTEN TABLE LAMPS

TL4100	18
TL4101	10
TL4102	24

WANDLEUCHTEN WALL LAMPS

WL3437	66
WL3484	23
WL3484-ST	23
WL3576	22
WL3580	31
WL3581	31
WL3582	28
WL3583	28
WL3586	65
WL3591	81
WL3592	66
WL3593	81
WL3603	23
WL3616	26
WL3625	25
WL3629	8
WL3630	59
WL3632-ST	62
WL3634	61
WL3635	72
WL3636	57
WL3637	74
WL3638	68
WL3639	34
33.000.087-B1	46

KERZENLEUCHTER CANDLE STICK

KL229	18/49
-------	-------

ÄNDERUNGEN IN FORM UND AUSFÜHRUNG UNSERER LEUCHTEN BLEIBEN UNS VORBEHALTEN. ALLE MASSE UND GEWICHTE SIND CIRCA ANGABEN AUFGRUND DER HANDWERKLICHEN FERTIGUNG.

WE RESERVE US THE RIGHT TO CHANGE THE SHAPE AND DESIGN OF OUR LIGHTING FIXTURES ALL MEASUREMENTS AND WEIGHT DECLARATIONS ARE APPROXIMAT DUE TO THE HAND MADE PRODUCTION.

NOUS NOUS RESERVONS LE DROIT DE MODIFIER LES CARACTERISTIQUES DE NOS PRODUITS SANS PREAVIS. LES DIMENSIONS ET LES POIDS SONT APPROXIMATIFS EN RAISON DE LA FABRICATION ARTISANALE DE NOS PRODUITS.

**HANDMADE
LIGHTING
FROM
GERMANY**

ROBERS-LEUCHTEN
GmbH & Co. KG
Weseker Weg 36
46354 Südlohn - Germany
Tel.: ++49 (0) 28 62 - 99 77 - 0
Fax: ++49 (0) 28 62 - 99 77 77
Net: www.Robers.com
Mail: office@Robers.com